

| | | |
|---|------------------|---|
|  | Document Number: | ES-IS-OP001 |
| | Document Title: | Instructions for Use—Cryopreservation Storage Systems |
| | Revision: | D |

Instructions for Use

Custom Biogenic Systems Cryopreservation Storage Systems



Designed and manufactured by:
Custom BioGenic Systems, a Biolife Solutions Company

www.biolifesolutions.com

74100 Van Dyke ♦ Bruce Township, Romeo MI 48065 ♦ USA
1.800.523.0072 ♦ Tel: 586.331.2600 ♦ Fax: 1.586.331.2588

Leading the World in Innovative Cryopreservation Technology Solution

| | | |
|---|------------------|---|
|  | Document Number: | ES-IS-OP001 |
| | Document Title: | Instructions for Use–Cryopreservation Storage Systems |
| | Revision: | D |



74100 Van Dyke Road
Bruce Township
Romeo
Michigan 48065 USA
biolifesolutions.com
sales@custombiogenics.com
1-800-523-0072
1-586-331-2600



FM 725612



NOTE: Custom Biogenic Systems Cryopreservation Storage Systems are Class A devices pursuant to FCC Part 15 Subpart B / ICES-003 IEC 61326-1:2012 / EN 61326-1:2013. A ‘Class A’ device may be marketed for use in a commercial, industrial or business environment.

CAUTION: This is a Class A product. In a domestic environment this product may cause radio interference, in which case the user may be required to take adequate measures.

Custom Biogenic Systems Cryopreservation Storage Systems have been tested to CAN/CSA-C22.2 NO. 61010-1-2012-05 and UL 61010-1:2012-05.

- The equipment has not been investigated for protection against ingress of water (IP code per IEC 60529)
- All wiring and installation shall be in accordance with electrical codes acceptable to the authorities in the countries where the equipment is installed and used.
- The equipment has been investigated for continuous operation in dry, pollution degree 2 environments at a maximum operating ambient temperature of 40°C.



| | | |
|---|------------------|---|
|  | Document Number: | ES-IS-OP001 |
| | Document Title: | Instructions for Use—Cryopreservation Storage Systems |
| | Revision: | D |

Table of Contents

| | | |
|-------------|--|-----------|
| 1.0 | Important Information | 4 |
| 2.0 | Warranty Information | 5 |
| 3.0 | Intended Use | 6 |
| 4.0 | Symbols | 6 |
| 5.0 | Liquid Nitrogen Safety | 7 |
| 6.0 | Product Safety | 9 |
| 7.0 | Recommendations for Safe Sample Cryostorage | 10 |
| 7.1 | Avoid corrective actions by eliminating or reducing risk. | 10 |
| 7.2 | Establish contingency measures. | 11 |
| 7.3 | Establish and maintain a quality program. | 11 |
| 7.4 | Monitor and control. | 12 |
| 7.5 | Equipment. | 13 |
| 8.0 | Operating Parameters | 14 |
| 9.0 | Transport, Handling and Storage | 15 |
| 10.0 | Unpacking | 16 |
| 11.0 | Cleaning and Decontamination | 16 |
| 12.0 | Liquid Nitrogen Supply Tank | 17 |
| 13.0 | Description of Models | 18 |
| 13.1 | Isothermal V-Series | 18 |
| 13.2 | Isothermal V-Series Carousel | 18 |
| 13.3 | Standard S-Series | 19 |
| 14.0 | Installation and Startup | 19 |
| 15.0 | Controller | 21 |
| 15.1 | Front Panel Controls | 21 |
| 15.2 | Back Panel Controls for 2301 Controller | 22 |
| 15.3 | Back Panel Controls for 5000 Series | 23 |
| 16.0 | Liquid Nitrogen Level Control and Alarms | 24 |
| 17.0 | Temperature Measurement and Alarms | 25 |
| 18.0 | Source Alarm | 25 |
| 19.0 | Lid Switch | 26 |
| 20.0 | Gas Bypass/Vent | 26 |
| 21.0 | Secure Program Mode | 26 |

| | | |
|---|------------------|---|
|  | Document Number: | ES-IS-OP001 |
| | Document Title: | Instructions for Use–Cryopreservation Storage Systems |
| | Revision: | D |

| | |
|---|----|
| 22.0 Data Logs | 27 |
| 23.0 On-Screen Functional Validation | 28 |
| 24.0 Global Remote Alarm Connection | 28 |
| 25.0 0-5Vdc or 4-20mA Outputs* | 29 |
| 26.0 Printer Port* | 29 |
| 27.0 Filling Features | 30 |
| 27.1 Filler Timer | 30 |
| 27.2 Fill/Vent in Progress | 30 |
| 27.3 SEQ/OFAF System* | 30 |
| 28.0 Manual Filling | 33 |
| 29.0 Preventive Maintenance | 34 |
| 30.0 Troubleshooting | 35 |
| 31.0 Parts List | 37 |
| 32.0 Disposal | 37 |

**The product images are for illustration purposes only and may not be an exact representation of the product.

***All designs and materials contained are protected under Federal copyright law.

Unauthorized distribution or use will be subject to prosecution to the fullest extent of the law.

| | | |
|---|------------------|---|
|  | Document Number: | ES-IS-OP001 |
| | Document Title: | Instructions for Use–Cryopreservation Storage Systems |
| | Revision: | D |

1.0 Important Information

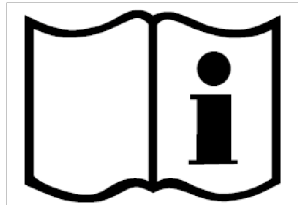

**Read and understand this manual completely before proceeding to set-up.
Save these instructions for future use.**

- Ensure all parts are accounted for and that no damage has occurred during shipping.
- The safety of any system incorporating this equipment is the responsibility of the assembler of the system.
- If this equipment is used in a manner not specified by Custom Biogenic Systems, the protection provided by the equipment may be impaired.
- Modifications or part substitutions to this unit are strictly forbidden. The unit does not have any user serviceable parts inside, DO NOT remove the protective housing.
- For maintenance, service, replacement and/or repair needs or if unsure of the proper set-up and use of this product, please contact Custom Biogenic Systems.

Customer / Technical Service:

Phone: (800) 523-0072 (US Only) (586) 331-2600 Fax: (586) 331-2600

customerservice@custombiogenics.com

sales@custombiogenics.com

| | | |
|---|-------------------------|--|
|  | Document Number: | ES-IS-OP001 |
| | Document Title: | Instructions for Use–Cryopreservation Storage Systems |
| | Revision: | D |

2.0 Warranty Information

Custom Biogenic Systems warrants all manufactured cryogenic equipment to be free from defects in workmanship or materials for a period of five-year vacuum warranty and a 2-year warranty on electronics and parts.

Custom Biogenic Systems liabilities under the warranty shall be limited to correcting or replacing defective workmanship or materials. A claimant under the warranty must notify Custom Biogenic Systems within ten (10) days after the discovery of the defect. Custom Biogenic Systems reserves the right, at their discretion, to correct the defect(s) in the field without return shipment to the factory.

This warranty does not cover defects on cryogenic equipment resulting from abusive handling and subsequent structural failure.

Serial Number: _____

Model Number: _____

| | | |
|---|-------------------------|--|
|  | Document Number: | ES-IS-OP001 |
| | Document Title: | Instructions for Use–Cryopreservation Storage Systems |
| | Revision: | D |

3.0 Intended Use

A mains electricity (AC-powered) laboratory appliance designed to create a cryogenic environment below the point when most all biological activity ceases, using liquid nitrogen (LN2) as the cooling and storage agent.

4.0 Symbols

Safety Symbols



CAUTION

The safety statement that follows this safety alert symbol indicates a hazardous situation which, if not avoided, has the potential to cause damage to property or equipment.



WARNING

The safety statement that follows this safety alert symbol indicates a hazardous situation which, if not avoided, has the potential to cause bodily harm or death.

Product Symbols



PROTECTIVE TERMINAL CONNECTION



DIRECT CURRENT

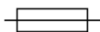

FUSE

| | | |
|---|------------------|---|
|  | Document Number: | ES-IS-OP001 |
| | Document Title: | Instructions for Use—Cryopreservation Storage Systems |
| | Revision: | D |

5.0 Liquid Nitrogen Safety

Properties of Liquid Nitrogen (LN2)

| | |
|-------------------------------|---|
| Boiling Point @ 1 atm | -195.8°C , -320.3°F , 77.4 K |
| Thermal Conductivity (Gas) | 25.83 mW/(m·K) |
| Heat of Vaporization (Liquid) | 198.38 kJ/kg |
| Density @ 1 atm (Liquid) | 1.782 lbs/L , 807.4 g/L , 808.6 kg/m ³ |



Liquid nitrogen is extremely cold, -196°C at atmospheric pressure. This can cause **severe frost bite** or **eye damage** upon contact. The use of personal protective equipment is required.



On vaporization liquid nitrogen expands by a factor of 700; one liter of liquid nitrogen becomes 24.6 cubic feet of nitrogen gas. This can cause **explosion** of a sealed container, or it can displace oxygen in the room and cause **suffocation without warning**.

- All personnel should have a complete knowledge of the correct procedures, as well as the hazards of working with liquid nitrogen. Have available the Safety Data Sheet (SDS) provided by your liquid nitrogen supplier for appropriate first aid measures.
- Always wear proper personal protective equipment when working with liquid nitrogen, including a face shield, safety goggles, cryo-gloves and cryo-aprons. Gloves should be loose fitting, so they could be thrown off if liquid were to pour inside them.
- Wear closed toe shoes, long pants without cuffs and a buttoned lab coat. Do not tuck pants into shoes/boots.
- Use only unsealed containers approved for use with liquid nitrogen. Never pour it into a coffee thermos. Never seal it in any container (it will explode).
- Handle the liquid nitrogen slowly to minimize boiling and splashing. Introducing room temperature items into liquid nitrogen may cause boiling and splashing.

| | | |
|---|-------------------------|--|
|  | Document Number: | ES-IS-OP001 |
| | Document Title: | Instructions for Use–Cryopreservation Storage Systems |
| | Revision: | D |

- Substances may become brittle upon contact with liquid nitrogen and shatter, sending pieces flying.
- Never dip a hollow tube into liquid nitrogen, it may spurt liquid.
- Never dispose of liquid nitrogen by pouring it on the floor. It could displace enough oxygen to cause unconsciousness and asphyxiation.
- Never use liquid nitrogen in a small poorly ventilated area. Liquid Nitrogen is a heavy gas, it falls to the floor first and fills the room from floor to ceiling. In all areas where liquid nitrogen is used, install oxygen sensors with low-oxygen alarms placed at typical breathing height.
- When transferring liquid nitrogen, oxygen in the air surrounding a cryogen containment system can dissolve and create an oxygen-enriched environment. Since the boiling point of nitrogen is lower than oxygen's, liquid oxygen evaporates slower than nitrogen and may build up to levels which can increase the flammability of materials such as clothing near the system. Equipment containing cryogenic fluids must be kept clear of combustible materials in order to minimize the fire hazard potential. Condensed oxygen in a cold trap may combine with organic material in the trap to create an explosive mixture.
- Never use in combination with other substances without knowing what the result will be.

| | | |
|---|------------------|---|
|  | Document Number: | ES-IS-OP001 |
| | Document Title: | Instructions for Use—Cryopreservation Storage Systems |
| | Revision: | D |

6.0 Product Safety



DO NOT use the unit outdoors or in a wet environment.

DO NOT install the unit in a flammable, volatile or corrosive location.

DO NOT insert objects into any vent, gap or any outlet on the unit. This may cause electric shock or injury.

Disconnect the power supply to the unit prior to any repair or maintenance to prevent electric shock or injury.

DO NOT touch any electrical parts with a wet hand, this may cause electric shock.

DO NOT splash liquid directly onto the unit as this may cause electric shock or short circuit.



ELECTRICAL SHOCK HAZARD. To avoid risk of electrical shock, this equipment must be connected to a properly grounded power source outlet. If the power supply outlet is not grounded, it will be necessary to install a ground by qualified engineers.



FALLING LID HAZARD. Use both hands while opening and lowering the lid. Lid should be opened fully each time to minimize wear on hinges and shocks.



ROLLING HAZARD. Ensure casters are properly locked. For units with locking casters, push down on the *lock* tab, to disengage, pull-up on the locking tab. For units that include a Wheel Lock Assembly, install according to the instructions included.

DO NOT put containers with liquid on the unit as this may cause electric shock or short circuit if the liquid is spilled.

Ensure the power supply cord and plug remain free of damage.

DO NOT replace the detachable MAINS supply cord with an inadequately RATED cord. Replacement Cord sets must be fully approved and rated for the country of use.

DO NOT disassemble, repair, or modify the unit yourself.

When removing the plug from the power supply outlet, grip the power supply plug, NOT the cord.

| | | |
|--|-------------------------|---|
|  Biolife Solutions | Document Number: | ES-IS-OP001 |
| | Document Title: | Instructions for Use–Cryopreservation Storage Systems |
| | Revision: | D |

7.0 Recommendations for Safe Sample Cryostorage

The most important element of a cryostorage system is ensuring a constant range of temperatures below a minimum critical threshold. The upper limit of the range should be well below the critical temperature for the stored specimen to allow for any compromise during retrieval activities and sufficient time to act in the event of equipment malfunction or emergency situation. Questions to consider when developing standard operating procedures:

- Does your facility have a documented emergency plan to protect specimens in the event of a power failure, emergency or natural disaster?
- Does your facility monitor and record the temperature of stored specimens?
- Does your facility maintain and track temperature excursion information?
- Does your facility have a documented quality program?
- Does your facility have a documented risk management process for ensuring the safe storage of specimens?
- Does your facility have documented contingency procedures should equipment malfunction?
- Does your facility have a security system in place to prevent unauthorized access to cryostorage areas?
- Does your facility have an uninterruptible power supply to critical cryostorage areas?

7.1 Avoid corrective actions by eliminating or reducing risk

1. Perform a risk assessment to identify anything that may adversely affect stored specimens.
2. Eliminate and reduce as much as possible any risks identified.
3. Establish contingency plans for any risks remaining.

| | | |
|---|-------------------------|---|
|  | Document Number: | ES-IS-OP001 |
| | Document Title: | Instructions for Use–Cryopreservation Storage Systems |
| | Revision: | D |

7.2 Establish contingency measures

1. Develop a documented emergency plan considering possible scenarios that may lead to or cause disruption of operations. Test the plan to ensure effectiveness.
2. Have back-up cryostorage vessels available that can be brought into use rapidly should malfunction occur. A cryostorage vessel at room temperature may take several hours to cool down sufficiently for transfers to take place. Back-up vessels should be maintained in reserve at operating temperature.
3. Maintain a back-up supply of liquid nitrogen.
4. Split specimens into at least two cryostorage vessels in different locations on site and also to a second site. Ensure that the storage maintenance procedures and general quality of storage are at least equivalent to those at the original site.
5. Establish a list of emergency personnel who are trained to execute contingency measures.
6. Resources for equipment repair and replacement should be identified before an emergency is experienced. These resources should be reviewed on an annual basis.

7.3 Establish and maintain a quality program

1. Establish and maintain a quality program intended to prevent improper storage conditions.
2. Ensure corrective actions of deficiencies are taken and documented. Actions taken should be verified to ensure they are effective and include both short-term actions to address the immediate problem and long-term actions to prevent recurrence.
3. Ensure that personnel involved in cryostorage activities are properly, continuously and consistently trained and only perform those activities for which they are qualified and authorized.
4. Ensure the effectiveness of the quality program by conducting and documenting periodic, independent audits of all cryostorage activities.

| | | |
|---|-------------------------|--|
|  | Document Number: | ES-IS-OP001 |
| | Document Title: | Instructions for Use–Cryopreservation Storage Systems |
| | Revision: | D |

7.4 Monitor and control

1. Establish acceptable temperature limits for all specimens in cryostorage.
2. Each cryostorage vessel should have an automatic temperature monitoring system that continuously monitors temperature and liquid nitrogen levels, securely records the information and generates audit trails that are tamper-proof.
3. Independently record the date and time of operator entries and actions that create, modify or delete electronic records. Record changes should not obscure previously recorded information.
4. Each cryostorage vessel should have an independent temperature alarm as well as a secondary or back-up temperature alarm.
5. Alarms should be tested daily to ensure proper functioning.
6. Ensure alarm systems are capable of notifying authorized persons (email, fax, text messaging) and of triggering, when necessary, pre-defined procedures. Alarms should be confirmed with comments.
7. Alarm conditions should be responded to in a time frame that eliminates the likelihood of damage to the stored specimens.
8. Personnel with adequate training who can take corrective action should be available or reachable 24 hours per day, seven days per week.
9. Establish a documented procedure for periodically reviewing recorded temperatures to ensure they have remained within the established acceptable limits and to facilitate the identification of negative performance trends.
10. Record daily LN2 usage either by monitoring the display levels or by manual means as excessive LN2 usage can indicate problems with the vacuum component of the cryostorage vessel.

| | | |
|---|-------------------------|---|
|  | Document Number: | ES-IS-OP001 |
| | Document Title: | Instructions for Use—Cryopreservation Storage Systems |
| | Revision: | D |

7.5 Equipment

1. Ensure cryostorage equipment is suitably located and installed to facilitate proper operation and maintenance. The proper performance of all cryostorage vessels should be verified or qualified prior to use.
2. Establish procedures and schedules for maintaining cryostorage equipment to ensure proper function.
3. Routinely inspect all cryostorage equipment to ensure adherence to maintenance schedules.
4. Routinely calibrate the controller used to regulate the liquid nitrogen levels of cryostorage vessels. Calibration should be against a traceable standard, if available. Where no traceable standard is available, the basis for calibration should be described and documented. If controller is found to be out of calibration or specification, there should be a defined process for action required for specimens stored since the last calibration.
5. Maintain spare parts for cryostorage equipment, especially for aging equipment for which parts may not be readily available.
6. Document and maintain records of all maintenance, repair, calibration, and other activities performed on the cryostorage equipment that may influence performance. The records should identify the person performing the work and the dates of the various entries and must be as detailed as necessary to provide a complete history of the activity performed. These records should be near each cryostorage vessel or be readily available to the individuals responsible for performing these activities and to the personnel using the equipment to ensure verification of compliance with the maintenance schedule daily prior to use.

Recommendations based on information compiled from:
 Title 21 Food and Drugs, Chapter I—Food and Drug Administration, Department of Health and Human Services,
 Subchapter L—Regulations Under Certain Other Acts Administered by the Food and Drug Administration
 PART 1271 Human Cells, Tissues, and Cellular and Tissue-Based Products
 Subpart D--Current Good Tissue Practice

International Society for Biological and Environmental Repositories (ISBER)

American Association of Blood Banks (AABB)

American Association of Tissue Banks (AATB)

| | | |
|---|-------------------------|--|
|  | Document Number: | ES-IS-OP001 |
| | Document Title: | Instructions for Use—Cryopreservation Storage Systems |
| | Revision: | D |

8.0 Operating Parameters

The systems are designed to operate under the following conditions:

- Indoor use only
- Altitude (maximum): 2000 m
- Ambient temperature range: 5 °C to 40 °C
- Relative humidity (maximum for ambient temperature): 80% for temperatures up to 31 °C, decreasing linearly to 50% at 40 °C

| | |
|--|--|
| CONTROLLER DIMENSIONS | CLAMSHELL TRAY |
| LENGTH | 9.38 (238) 8.47 (215) |
| WIDTH | 16.17 (411) 12.5 (318) |
| HEIGHT | 5.74 (146) 3.77 (96) |
| WEIGHT LBS (kg) | 5.7 (2.59) 3.9 (1.77) |
| MATERIALS OF CONSTRUCTION | |
| VESSEL | 304 Stainless Steel |
| SURROUND | Fiberglass, polyester resin, Class 1 flame rating ASTME-84 |
| ELECTRONICS / PCB | ROHS |
| SMT & CONVENTIONAL COMPONENTS | UL94V rating |
| DISPLAY | |
| TYPE | Liquid Crystal Display |
| SIZE | STN Positive Yellow Green backlight |
| VIEW AREA (WXH) | 40x4 |
| CHARACTER SIZE (WXH) | 148.0mm x 30.3mm |
| KEYPAD | 2.78mm x 4.89mm |
| KEY-LOCK | 6 button multifunction membrane switches Power / Program locking |
| ELECTRICAL AC MAIN POWER | |
| INPUT POWER | 100VAC~240VAC |
| INPUT FREQUENCY | 50HZ/60HZ |
| INPUT CURRENT (max) | 2 AMPS (fused) |
| POWER CONSUMPTION (max) | 222mA @ 120VAC/60HZ (144mA@220VAC/60HZ) |
| POWER CONSUMPTION (typical) | 77mA @ 120VAC/60HZ |
| MAIN FUSE | 2 AMP @ 250VAC TYPE 3AG/AB SLO-BLO |
| ELECTRICAL DC POWER SUPPLY | |
| | CLASS II / EARTH GROUNDED UL 60601-1, CUL TO 22.2NO.601, TUV TO EN60601 cTUVus CE FOR EMC, PSE TO J60950 / ROHS |
| MODEL | GLOBTEK / GLOBTEK / GTM21097-5024 / TR9C12100LCP-Y-MED-R |
| AC POWER CORD / PROTECTION | 18AWG, 3-PINS, Class I with functional earth |
| INPUT VOLTAGE / FREQUENCY (min / max) | 100VAC~240VAC, 50/60HZ |
| OUTPUT VOLTAGE | 24VDC +/- 5% Regulated |
| OUTPUT CURRENT | 2.1 AMP MAX |
| OUTPUT POWER (max) | 50W |
| POWER CONSUMPTION (monitoring) | 9 watts |
| POWER CONSUMPTION (2 valves energized / filling) | 26 watts |
| HOUSING | 94V0 Polyester |
| I/O CONNECTIONS | |
| GLOBAL REMOTE CONTACTS | 3-PIN: DRY CONTACTS, 24VDC / 2A (max) |
| FILL SOLENOID | 24VDC@2A (max) |
| VENT SOLENOID | 24VDC@2A (max) |
| 4-20mA (2301 only) | 400-ohms max loop impedance |
| 0-5V analog output (2301 only) | 25mA maximum to load |
| THERMOCOUPLES | |
| TYPE | 3 total (VENT/LID-A/LID-B) Type T (copper-constantan) suited for measurements in the -200 to +200°C range in oxidizing atmospheres. |
| ACCURACY (standard type-T) | +/- 1.0C or +/- .75% |
| TEMPERATURE MEASUREMENT | |
| RESOLUTION | 1°C resolution on display (-200°C to +25°C) |
| ACCURACY | +/-2.0°C or 1% range (2-point calibration) |
| LEVEL MEASUREMENT | |
| PRESSURE SENSOR | Differential type |
| RANGE | 0~1-PSI (6.9kPa) +/- 1%, 20psid proof |
| RESOLUTION | +/- 0.1-inch display (1" set-point adjustment) |
| ACCURACY | 0.5-inch (12.5mm) LN ₂ actual level |

| | | |
|---|------------------|---|
|  | Document Number: | ES-IS-OP001 |
| | Document Title: | Instructions for Use–Cryopreservation Storage Systems |
| | Revision: | D |

9.0 Transport, Handling and Storage



- Vehicles used to transport the device should be properly designed and equipped to ensure protection from different environmental and weather conditions in which it operates. The use of vehicles with defects that could affect the quality of the device should be avoided.
- The device must be handled and transported in the upright position.
- Do not stack or store material on the device or its surfaces.
- Do not lift the device using machinery unless properly packaged.
- The device is considered stationary equipment. Casters and handles are provided to assist positioning the device into place.
- Areas designated for the storage of these devices shall be designed or adapted as to meet the following conditions:
 - The area should be clean and dry.
 - All doors should preferably be outward opening and wide enough to provide easy access and exit routes for personnel.
 - The floor of the designated area should be level and strong enough to take the mass of the fully loaded unit.
 - The area should be suitably spaced to allow cleaning and inspection.
 - All surfaces should be made of or covered by an impermeable material to enable proper and safe cleaning.
 - Areas should be adequately lit and ventilated for tasks to be performed in a correct and safe manner.
 - In case of a recall by the manufacturer, the establishment shall be able to trace a product in the storage area by its lot / batch / serial number.

| | | |
|---|------------------|---|
|  | Document Number: | ES-IS-OP001 |
| | Document Title: | Instructions for Use—Cryopreservation Storage Systems |
| | Revision: | D |

10.0 Unpacking

Always inspect the bill of lading for accuracy and external crate/packaging for damage before accepting the shipment. Each Cryopreservation Storage System is packed securely on a wood pallet, in a cardboard box surrounded by foam.

1. Remove the top of the box.
2. Using a box cutter, cut down the corner of the box and peel the cardboard and foam away from the unit. Discard packing material.
3. Using side cutters, cut the tie down straps and discard.
4. Using a forklift, gently lift the unit off the pallet. White glove delivery service is available if required and requested.

11.0 Cleaning and Decontamination

NOTE: It is the responsibility of the organization to determine cleaning method and schedule that is appropriate for the intended use. The units are NOT provided sterile.

Deenergize equipment before attempting any cleaning process. Solutions that do not react with stainless may be used. Alcohol solutions are a commonly used disinfectant for use on electrical equipment. Moisten a microfiber cloth or lint-free cloth towel with an isopropyl alcohol solution (70% solution) with the balance being clean water. Allow the equipment to dry thoroughly before putting back into service.

DO NOT

- Remove or deface equipment markings by any cleaning or disinfection action.
- Do not spray or saturate liquids on to electrical equipment.
- Do not apply corrosive or petroleum-based substances on to the equipment.
- Similarly, do not fog equipment with disinfectant. *These media may cause electrical shock or injury. They may also result in degradation of components or materials in electrical equipment, leading to hazards immediately or over the equipment life.*

To perform the cleaning procedure, cover all inner surfaces with the cleaning solution, let stand for 30 minutes and remove. Spraying the solution into the inner vessel is preferred, although agitation of the solution inside the inner vessel will suffice. Rinse the surface with clean water and ensure all cleaner residue has been removed. Allow the unit to dry completely before putting back into service.

| | | |
|---|-------------------------|--|
|  | Document Number: | ES-IS-OP001 |
| | Document Title: | Instructions for Use–Cryopreservation Storage Systems |
| | Revision: | D |

12.0 Liquid Nitrogen Supply Tank

Liquid Nitrogen Supply Tanks must be operated in accordance with the manufacturer / supplier instructions. Safety instructions will also be posted on the side of each tank. Liquid nitrogen tanks must be kept in a well-ventilated area protected from weather and away from heat sources. The supply tank must be replenished at regular intervals to ensure proper operation of the cryopreservation storage system. When exchanging supply tanks, follow the procedure below:

1. Allow all plumbing components to warm to room temperature before changing supply tanks.
2. Close all valves associated with the supply tank.
3. Loosen the plumbing connection for the transfer hose at the supply tank.
4. Remove empty supply tank and replace with a full supply tank pressurized to 22 psig (1.52 bar).
5. Attach the provided transfer hose to the plumbing connection on the supply tank. Ensure the hose is connected to the connection labeled “LIQUID”.
6. Tighten the transfer hose plumbing connection at the supply tank.
7. Open the liquid supply valve on the supply tank.
8. Inspect plumbing for leaks. Leaking valves or connections must be depressurized before rectification.

| | | |
|---|------------------|---|
|  | Document Number: | ES-IS-OP001 |
| | Document Title: | Instructions for Use—Cryopreservation Storage Systems |
| | Revision: | D |

13.0 Description of Models

There are several series of storage systems with specialized features and functionality. Each system is equipped with an autofill controller and gas bypass feature.

13.1 Isothermal V-Series

The V-Series systems are a true dry storage environment. The liquid nitrogen is contained inside the vessel walls and the stored samples do not come into contact with the liquid nitrogen. The average internal temperature is -190°C , providing liquid nitrogen temperatures without liquid nitrogen contact. This series features a wide lid opening for unrestricted access to all storage samples and a convenient workspace.

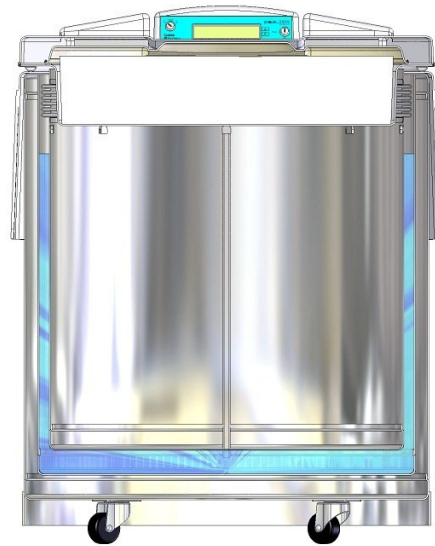

13.2 Isothermal V-Series Carousel

The V-Series Carousel systems are a true dry storage environment. The liquid nitrogen is contained inside the vessel walls and the stored samples do not come into contact with the liquid nitrogen. The average internal temperature is -190°C , providing liquid nitrogen temperatures without liquid nitrogen contact. This series features a square lid opening for easy retrieval of sample racks and an external handle for rotating the carousel safely.



| | | |
|---|-------------------------|--|
|  | Document Number: | ES-IS-OP001 |
| | Document Title: | Instructions for Use—Cryopreservation Storage Systems |
| | Revision: | D |

13.3 Standard S-Series

The S-Series systems are designed for liquid nitrogen immersion storage. This series features a wide lid opening for unrestricted access to all storage samples and a convenient workspace.

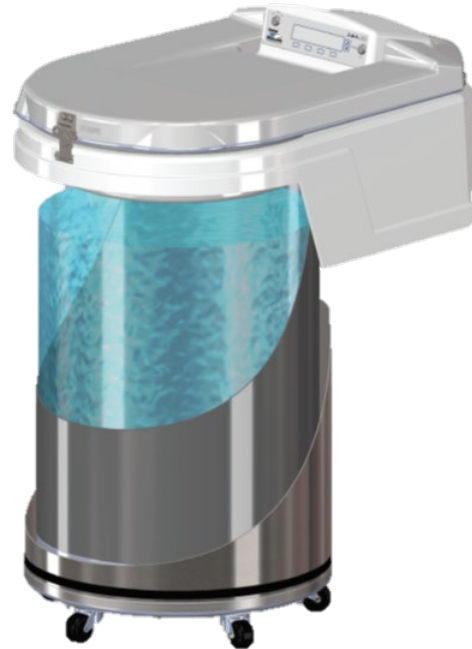

14.0 Installation and Startup

Included with each Custom Biogenic System Cryopreservation Storage System:

- Instructions for Use
- 6 Foot LN2 Transfer Hose
- 1 set of controller keys
- 1 set of lid lock keys
- LN2 Level Measuring Stick (S-Series only)

Tools Required for Startup:

- Adjustable wrench
- Two supply tanks, 180 liters or larger (or bulk tank liquid nitrogen source)

After unpacking and cleaning the unit, move to the location where it will be installed and used. See Sections 9.0 and 10.0 for additional instructions. As applicable, lock the casters to the unit or install the caster locking mechanism provided with the unit. The unit requires a liquid nitrogen supply source, either an independent supply tank or a pipeline connected to a bulk tank that is between 18-25 psi (1.24-1.72 Bar).

| | | |
|---|-------------------------|---|
|  | Document Number: | ES-IS-OP001 |
| | Document Title: | Instructions for Use—Cryopreservation Storage Systems |
| | Revision: | D |

NOTE: *Maintain a back-up supply of liquid nitrogen should an interruption in supply occur.*

1. Connect the provided 6-foot LN2 transfer hose to the liquid side of the liquid nitrogen supply tank. Connect the other end to the Custom Biogenic Systems unit. See *Section 11.0 for detailed instructions.*
2. Plug the power cord into the appropriate power source.
3. Turn the Power key to the **ON** position. The factory default setpoints are:

| Model | Low | High |
|--------------|-------------------|-------------------|
| S-Series | 4 inches / 10 cm | 6 inches / 15 cm |
| V-Series | 10 inches / 25 cm | 17 inches / 43 cm |

4. The lid shall remain open until the first fill is complete.
5. Open the valve to the liquid nitrogen supply. The unit will automatically begin to fill.
6. All Custom Biogenic Systems Cryopreservation Storage Systems have the option to vent warm nitrogen gas. This is recommended when a pipeline with a bulk tank is being used for the liquid nitrogen supply. To enable the bypass option, see *Section 19.0 for instructions.*

The unit will initiate a low-level alarm during the initial fill while the liquid nitrogen level is below the default setpoint.

The unit will take approximately 30-90 minutes for the initial fill. Fill times may vary depending upon the supply source.

The unit will automatically stop filling when the liquid level reaches the high level setpoint. The lid may now be closed. Allow the temperature to stabilize 2-3 days before changing the high temperature setpoint, performing IQ/OQ, any testing or storing product.

| | | |
|---|------------------|---|
|  | Document Number: | ES-IS-OP001 |
| | Document Title: | Instructions for Use–Cryopreservation Storage Systems |
| | Revision: | D |

15.0 Controller

15.1 Front Panel Controls

NOTE: DO NOT use pointed objects for button selection, this will cause damage to the display overlay.

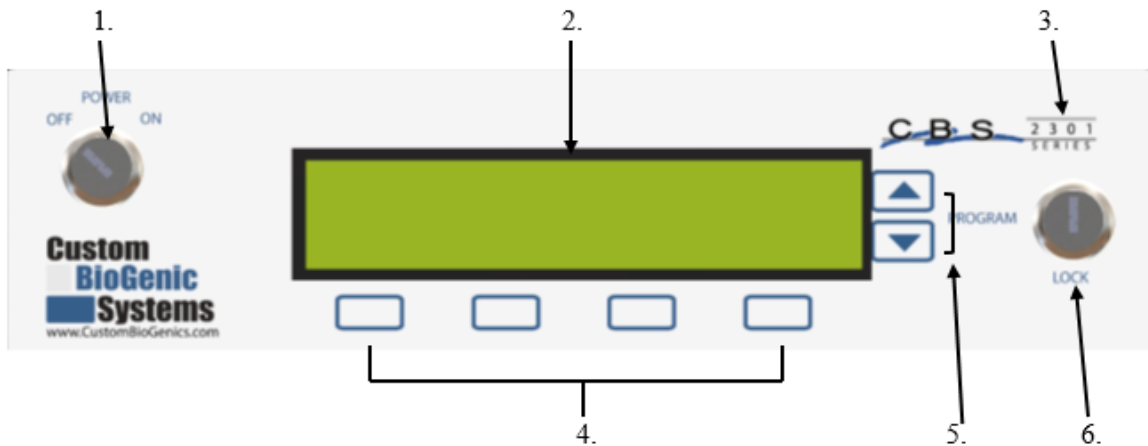

| | | |
|----|--------------------------|---|
| 1. | Power/Program Key Switch | Main power control for the unit. |
| 2. | LCD Display | 40x4 LCD Display with backlight. |
| 3. | Label | Identifies the model number of the controller (2301 or 2200). |
| 4. | Menu Buttons | Navigate controller and select options shown on the display. |
| 5. | Up/Down Arrows | Used to toggle or scroll through values. |
| 6. | Program/Lock Key Switch | Changes the mode between standard and Program. This protects unauthorized users from changing controller programming. |

| | | |
|---|------------------|---|
|  | Document Number: | ES-IS-OP001 |
| | Document Title: | Instructions for Use—Cryopreservation Storage Systems |
| | Revision: | D |

15.2 Back Panel Controls for 2301 Controller

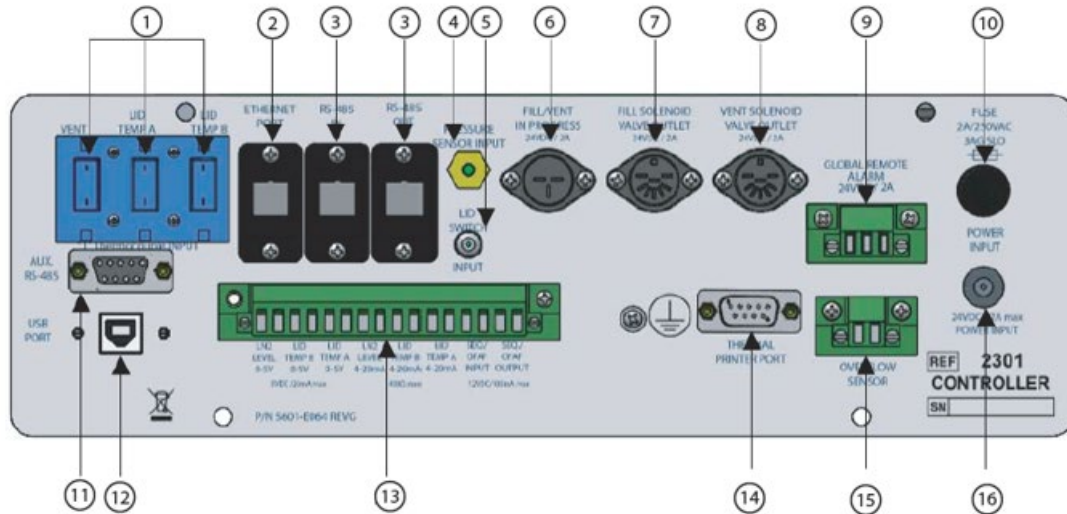

| | | |
|------|--------------------------------------|--|
| 1. | Female Temperature Probe Assembly | Plugs for Vent, Temp A and Temp B Thermocouples |
| 2/3. | Ethernet Port, RS-485 IN, RS-485-OUT | Connections for future expansion |
| 4. | Sensor Port | Port for the sensor hose that connects from the vessel to the controller |
| 5. | Lid Switch Input | Connection for Lid Switch |
| 6. | Fill/Vent in Progress Plug | Outputs 24V DC when filling or venting. (Optional Use) |
| 7. | Fill Solenoid Valve Outlet | Plug for FILL valves |
| 8. | Vent Solenoid Valve Outlet | Plug for VENT valve |
| 9. | Global Remote Alarm | Dry contact that switches status when any alarm occurs |
| 10. | 2 Amp Fuse Housing | Holds 2 Amp Slow Blow fuse |
| 11. | AUX RS 485 Port | Connection for future expansion |
| 12. | USB Port | Connection for future expansion |
| 13. | 16 Port Connector | 0-5VDC and 4-20mA Outputs for Temp A, B and Level |
| 14. | Thermal Printer Port | Plug to connect thermal printer for reports |
| 15. | Overflow Sensor Port | Discontinued |
| 16. | Power Supply Plug | Plug for the 24V medical power supply |

| | | |
|---|------------------|---|
|  | Document Number: | ES-IS-OP001 |
| | Document Title: | Instructions for Use—Cryopreservation Storage Systems |
| | Revision: | D |

15.3 Back Panel Controls for 5000 Series

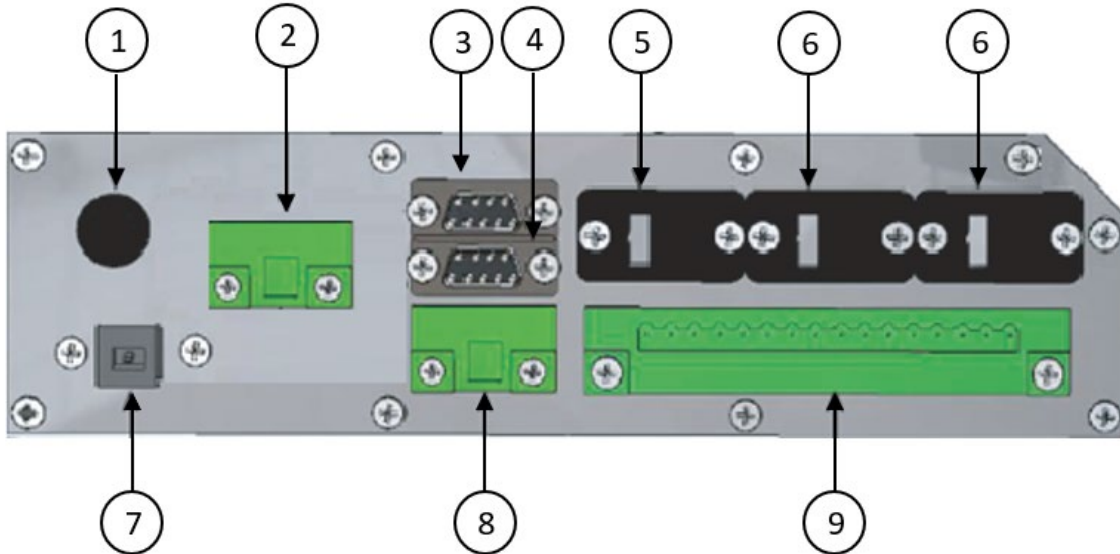

| | | |
|----|----------------------|---|
| 1. | 2 Amp Fuse | VAC 2 amp buss fuse; 220 volts slow-blow (T2A-250V) |
| 2. | Global Remote Alarm | Dry contact that switches status when any alarm occurs. All Global Alarm connections are dry contact relays with a max output of 24VDC@2A |
| 3. | Thermal Printer Port | Used for printing alarms and data |
| 4. | Aux RS-485 Port | RS-485 communications for future expansion |
| 5. | Ethernet Port | Communications for future expansion |
| 6. | RS-485 IN | Communications for future expansion |
| 6. | RS-485 OUT | Communications for future expansion |
| 7. | USB Port | Communications for future expansion |
| 8. | Overflow Sensor | Discontinued |
| 9. | 16 Port Connector | 0-5VDC and 4-20mA Outputs for Temp A, Temp B and Level. |

| | | |
|---|------------------|---|
|  | Document Number: | ES-IS-OP001 |
| | Document Title: | Instructions for Use—Cryopreservation Storage Systems |
| | Revision: | D |

16.0 Liquid Nitrogen Level Control and Alarms

The controller activates the fill solenoid valve when the liquid nitrogen level drops below the low-level set point. The solenoid valve deactivates when the liquid nitrogen level reaches the high-level set point, stopping the fill. The set points can be adjusted with a range from 0 inches (0 cm) up to 30 inches (76 cm).

The liquid nitrogen level is controlled in the program mode. To change the settings, follow the steps below.

1. Turn the key to **PROGRAM**.
2. Select **LIQ'D LEVEL**.
3. Select **INCHES** or **CENTIMETERS**.
4. Use the buttons below the horizontal arrows to toggle between **HI SET** and **LO SET**.
5. Use the arrow keys on the right side of the controller to adjust the **HI SET**.
6. Select **ENTER**. Settings will not be saved if **ENTER** is not selected.
7. Turn the key to the **LOCK** position.

When the liquid nitrogen level drops to the low setpoint, an autofill is triggered and the solenoid valves open. If the level remains at or below the low setpoint for seven minutes, an audible and visual alarm activates ****LOW ALARM****.

When the liquid nitrogen level reaches the high setpoint during a fill, the solenoid valves close and the fill is stopped. If the level goes over the high setpoint for two minutes, an audible and visual alarm activates ****HIGH ALARM****.

| | | |
|---|------------------|---|
|  | Document Number: | ES-IS-OP001 |
| | Document Title: | Instructions for Use–Cryopreservation Storage Systems |
| | Revision: | D |

17.0 Temperature Measurement and Alarms

The controller measures temperature using two Type-T thermocouple probes, shown on the controller as **TEMP-A** and **TEMP-B**. The default length of the probes into the probe holder tube are shown below.

| Model | TEMP-A | TEMP-B |
|-------------------|---------------------|---------------------|
| V-Series | 12 inches / 30.5 cm | 20 inches / 50.8 cm |
| V-Series Carousel | 11 inches / 28 cm | 11 inches / 28 cm |
| S-Series | 12 inches / 30.5 cm | 20 inches / 50.8 cm |

The default temperature setpoint is 30° C to prevent temperature alarms from occurring during the initial fill. To change the setting follow the steps below.

1. Turn the key to **PROGRAM**.
2. Select **NEXT** to advance to **MAIN MENU 2**.
3. Select **TEMP**.
4. Select **F** (Fahrenheit) or **C** (Celsius).
5. Use the arrow keys on the right side of the controller to adjust **TEMP-A ALARM**.
6. Select **ENTER**.
7. Use the arrow keys on the right side of the controller to adjust **TEMP-B ALARM**.
8. Select **ENTER**.
9. Turn the key to the **LOCK** position.

If the temperature value on either Temp Probe A or Temp Probe B increases above the pre-set temperature, an audible and visual alarm activates ****TEMP-A HIGH**** or ****TEMP-B HIGH****.

18.0 Source Alarm

A timer begins when a fill is initiated. If the high level setpoint is not reached within the default 30 minutes, a source alarm will occur. This is to prevent filling with an empty or low-pressure supply source. The source alarm timer can be extended if needed, contact Custom Biogenic Systems for more information.

| | | |
|---|-------------------------|--|
|  | Document Number: | ES-IS-OP001 |
| | Document Title: | Instructions for Use—Cryopreservation Storage Systems |
| | Revision: | D |

19.0 Lid Switch

Some models are equipped with a lid switch. The controller will show ****LID OPEN**** and the event will be recorded in the Alarms Report. Units without a lid switch include carousel models and those with lift off lids.

20.0 Gas Bypass/Vent

Each unit is equipped with a bypass or vent valve to release LN₂ gas from the transfer lines prior to the activation of the fill solenoid valves. The bypass is typically enabled when the liquid nitrogen supply source is a distance away. When the bypass is enabled during a fill cycle, the vent valve will open first. When the display indicates approximately -160° C, the vent valve will close, and the fill valves will open. To enable the bypass function, follow the steps below.

1. Turn the key to **PROGRAM**.
2. Select **NEXT** to advance to **MAIN MENU 2**.
3. Select **BYPASS**.
4. Select **ON**.
5. Turn the key to the **LOCK** position.

To disable the bypass function, select **OFF** in step 4 above.

21.0 Secure Program Mode

PROGRAM mode is used to change settings on the controller. PROGRAM mode is accessible using a key. With the key removed, there is no access to change alarms and setpoints.

| | | |
|---|-------------------------|--|
|  | Document Number: | ES-IS-OP001 |
| | Document Title: | Instructions for Use—Cryopreservation Storage Systems |
| | Revision: | D |

22.0 Data Logs

The controller records alarms such as fill start, fill stop and lid openings. In addition to the Alarm Log the Data Log will record liquid nitrogen level, Temp-A and Temp-B on the hour at the interval specified. These are recorded in a first-in/first-out manner with 999 events stored. To turn this feature on follow the steps below.

1. Turn the key to **PROGRAM**.
2. Select **NEXT** three times to advance to **MAIN MENU 4**.
3. Select **LOG**.
4. Use the arrow keys on the right side of the controller to choose an interval from 1-99.
5. Select **ENTER**.
6. Turn the key to the **LOCK** position.

To view the Alarm Log or Data Log, follow the steps below.

1. Select **REPORT**.
2. Select the appropriate log, **ALARMS** or **DATA**.
3. Use the arrow keys to select a start date. Select **ENTER**.
4. Use the arrow keys to select a report end date. Select **ENTER**.
5. Choose **DISPLAY** to view the report on the controller. Choose **PRINT** if using a thermal printer.
6. When **DISPLAY** is chosen, cycle through the log by using **PREV** (previous) and **NEXT**.

| | | |
|---|------------------|---|
|  | Document Number: | ES-IS-OP001 |
| | Document Title: | Instructions for Use—Cryopreservation Storage Systems |
| | Revision: | D |

23.0 On-Screen Functional Validation

The controller is equipped with a validation feature. To access the validation feature, follow the steps below.

1. Turn the key to **PROGRAM**.
2. Select **NEXT** two times to advance to **MAIN MENU 3**.
3. Select **VALIDATION**.

Testing can be done on the overlay buttons, buzzer, remote contacts, all temperature probes, printer function, valves and lid switch. Test results may be printed.

24.0 Global Remote Alarm Connection

When a system alarm condition or power loss occurs, the global remote alarm will change state indicating an alarm has occurred.

Contacts can be used to interface with accessory items such as a remote dialer or local alarm system for notification of the alarm condition.

Global Remote Alarm
 Contacts are “DRY” or unpowered, rated at 24VDC @ 2A.

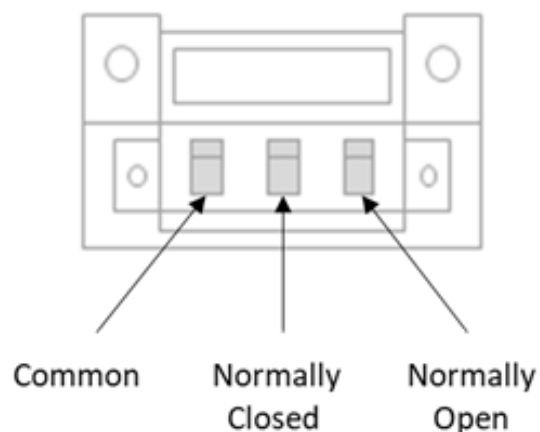

| | | |
|---|------------------|---|
|  | Document Number: | ES-IS-OP001 |
| | Document Title: | Instructions for Use–Cryopreservation Storage Systems |
| | Revision: | D |

25.0 0-5Vdc or 4-20mA Outputs*

The 2301 controller is equipped with outputs allowing the use of either 4-20mA or 0-5vdc for monitoring temperature and level. (See Section 7.0 for I/O specifications)

NOTE: Scaling is to the operational range of the controller.

Temperature:

| | | |
|--------|-------------|-------------|
| 0-5Vdc | 0V= -200°C | 5V= +50°C |
| 4-20mA | 4mA= -200°C | 20mA= +50°C |

Level:

| | | |
|--------|-----------|-------------|
| 0-5Vdc | 0V= 0.0" | 5V= 33.0" |
| 4-20mA | 4mA= 0.0" | 20mA= 33.0" |

Accuracy: +/- .5" for Level +/- 3°C for Temperature

To ensure the controller is outputting the correct signal follow the steps below.

1. Turn the key to **PROGRAM**.
2. Select **TANK ID**.
3. Select **NEXT MENU** twice.
4. Use the arrow keys on the right side of the controller to toggle between **4-20Ma** and **0-5V**.
5. Select **ENTER**.
6. Turn the key to the **LOCK** position.

26.0 Printer Port*

A printer port is available on 2301 controller to connect a thermal printer. Reports can be printed from the REPORT function of the controller. Validation test results can also be printed.

| | | |
|---|------------------|---|
|  | Document Number: | ES-IS-OP001 |
| | Document Title: | Instructions for Use—Cryopreservation Storage Systems |
| | Revision: | D |

27.0 Filling Features

27.1 Filler Timer

The fill timer will fill the unit at 24, 48 or 72-hour intervals at the time selected. The auto fill setting will always override the fill timer setting. To activate the fill timer, follow the steps below.

1. Turn the key to **PROGRAM**.
2. Select **NEXT** two times to **MAIN MENU 3**.
3. Select **FILL TIMER**.
4. Select **ENABLE**.
5. Select the interval (24, 48 or 72 hours).
6. Select the arrow keys on the right side of the controller and the **HR<->MIN** to enter the time for a fill to begin.
7. Select **ENTER**.
8. Turn the key to the **LOCK** position.

27.2 Fill/Vent in Progress

The Fill/Vent in Progress provides a signal to activate the CBS TS-1B LN2 Supply Tank Switcher, or an additional 24Vdc valve to control the liquid nitrogen supply. The signal is provided whenever filling or venting occurs.

27.3 SEQ/OFAF System*

***2301 controller only, not available on 2200 controller**

The SEQ/OFAF System is an option for units connected to a bulk supply liquid nitrogen source. The 2301 controllers are connected using a two-conductor wire connecting one 2301 controller SEQ/OFAF output to the next 2301 controller SEQ/OFAF input. Continue these connections until all the controllers are connected in a complete loop. To reset the system each controller must be powered OFF and ON. The connectors are located on the rear panel. After the controllers are connected, follow the steps below.

| | | |
|---|-------------------------|--|
|  | Document Number: | ES-IS-OP001 |
| | Document Title: | Instructions for Use—Cryopreservation Storage Systems |
| | Revision: | D |

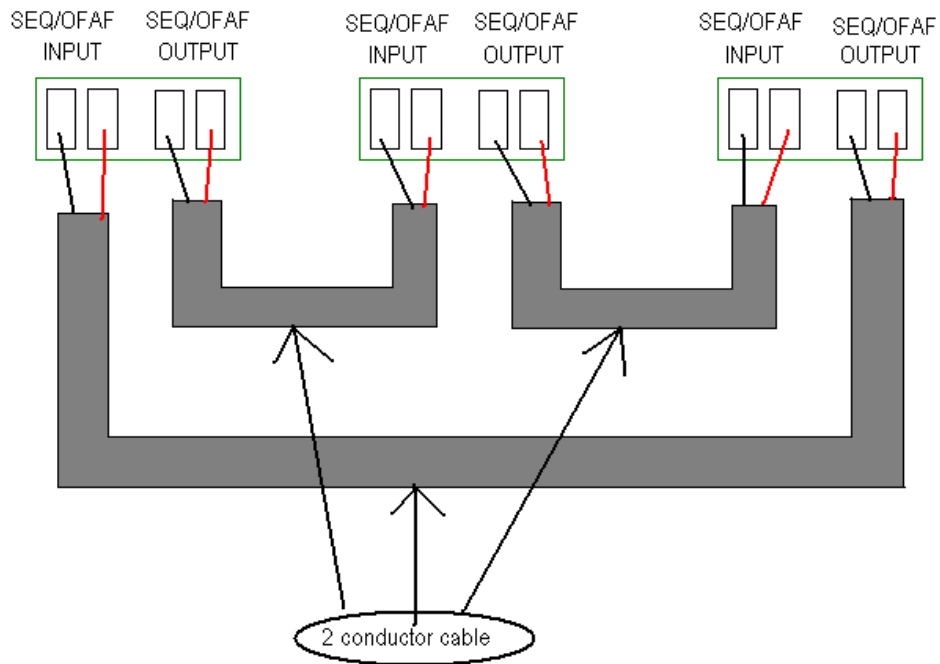

1. Turn the key to **PROGRAM**.
2. Select **NEXT** three times to **MAIN MENU 4**.
3. Select **OFAF**.
4. Select **SEQUENTIAL** or **SIMULTANEOUS**.
5. Select **ENTER**.

| | | |
|---|------------------|---|
|  | Document Number: | ES-IS-OP001 |
| | Document Title: | Instructions for Use—Cryopreservation Storage Systems |
| | Revision: | D |

Sequential Fill

The Sequential Fill option will maintain optimum fill pressure and significantly reduce liquid nitrogen transfer loss. Once the master controller reaches its high level, it will activate the next controller. This process will continue until all linked controllers have reached their high-level set point.

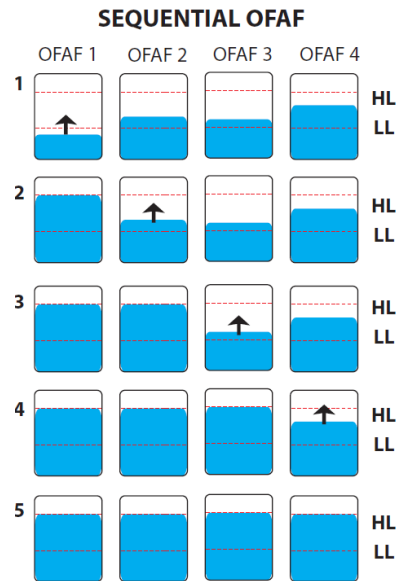

Simultaneous Fill

The Simultaneous Fill option will fill the units simultaneously until all linked controllers have reached their high-level set point.

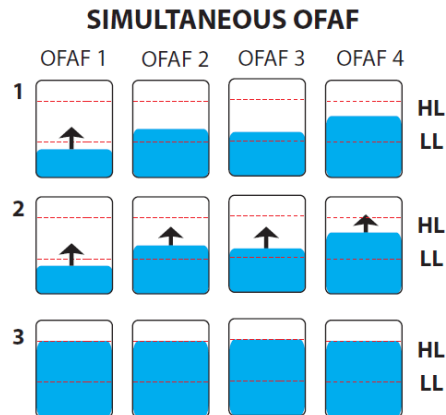

| | | |
|---|-------------------------|---|
|  | Document Number: | ES-IS-OP001 |
| | Document Title: | Instructions for Use—Cryopreservation Storage Systems |
| | Revision: | D |

28.0 Manual Filling

Manual filling may be necessary during a power outage or malfunction. The systems are equipped with a manual fill port located on the rear of the unit. To perform a manual fill, follow the steps below:

1. Turn off the liquid nitrogen supply valve at the supply tank.
2. Disconnect the supply line from the auto fill port.
3. Remove the cap from the manual fill port and replace it where the hose was removed. Tighten the cap.
4. Connect the liquid nitrogen supply line to the manual fill port and tighten.
5. Open the lid.
6. Open the valve on the liquid nitrogen supply.
7. **V-Series Models:** fill until the liquid nitrogen begins to “spit” from the vent closest to the fill line and close the supply source valve. Standard height units will contain approximately 25 inches of liquid nitrogen at this point.
8. Close the lid.
9. Repeat daily or until the auto fill function is restored.

| | | |
|---|------------------|---|
|  | Document Number: | ES-IS-OP001 |
| | Document Title: | Instructions for Use–Cryopreservation Storage Systems |
| | Revision: | D |

29.0 Preventive Maintenance

| Procedure | Daily | Weekly | 6-months | Annually | 5-Years |
|---|-------|--------|----------|----------|---------|
| Overall visual inspection | ✓ | | | | |
| Remove any ice build-up existing on underside of lid. Wipe away any condensation before closing | ✓ | | | | |
| Verify supply tank contains an adequate amount of LN ₂ | ✓ | | | | |
| Inspect all LN ₂ plumbing for leaks | | ✓ | | | |
| Run Validation Menu | | | ✓ | | |
| Inspect lid hinge for proper operation | | | ✓ | | |
| System calibration; temperature and liquid level | | | | ✓ | |
| Performance evaluation or preventive maintenance service | | | | ✓ | |
| Perform system thaw | | | | | ✓ |
| Clean or replace solenoid valves | | | | | ✓ |

| | | |
|---|-------------------------|---|
|  | Document Number: | ES-IS-OP001 |
| | Document Title: | Instructions for Use–Cryopreservation Storage Systems |
| | Revision: | D |

30.0 Troubleshooting

| Condition | Potential Causes | Solutions |
|--|---|---|
| <p>High Alarm Visual alarm SYSTEM STATUS ALARM **HIGH ALARM** Audible alarm present. Liquid level has risen above the high-level set point.</p> | <ul style="list-style-type: none"> FILL/START button damaged. Valves frozen due to long fill time or debris obstruction. Ice in sensor tube. | <ul style="list-style-type: none"> If the unit is filling, turn off the LN2 supply. Push the STOP button after the alarm is reset. Check that the FILL/START button is not damaged. Allow valves to thaw if frozen open. Check pressure of supply that it is no more than 25 PSI. If after being thawed the unit continues to overfill, there may be an obstruction. Remove solenoid valves and disassemble for service. Contact CBS for Fill Test. Unit may require thaw. |
| <p>Low Alarm Visual alarm SYSTEM STATUS ALARM **LOW ALARM** Audible alarm present. Liquid level has fallen below the low-level set point.</p> | <ul style="list-style-type: none"> Supply tank is empty, or pressure is too low. Supply tank is turned off. Sensor tube is not secure. Solenoid valve malfunction | <ul style="list-style-type: none"> Check supply tank pressure and level. Replace if needed. Open manual valve on supply tank or supply line. Check clear sensor hose connections on the tank and controller. Re-clamp or replace as needed. Reset the alarm and press FILL/STOP. After releasing, the “click” of the valves should be heard. If a click is not heard, the valve(s) or a connection to them may be defective. |
| <p>Source Alarm Visual alarm SYSTEM STATUS ALARM **SOURCE ALARM** Audible alarm present. Liquid level did not achieve the high level during a fill within a preset amount of time.</p> | <ul style="list-style-type: none"> Supply tank is empty, or pressure is too low. Supply tank is turned off. Unit is connected to a bulk supply with a long transfer line. | <ul style="list-style-type: none"> Check supply tank pressure and level. Replace if needed. Open manual valve on supply tank or supply line. Source timer may be extended. Call CBS for instructions. |

| | | |
|---|-------------------------|--|
|  | Document Number: | ES-IS-OP001 |
| | Document Title: | Instructions for Use–Cryopreservation Storage Systems |
| | Revision: | D |

| Condition | Potential Causes | Solutions |
|--|--|---|
| Temperature Alarm Visual Alarm SYSTEM STATUS ALARM **TEMP A** or **TEMP B** Temperature has risen above the programmed set point. | <ul style="list-style-type: none"> Lid was left open. Probe has been moved. Probe has been damaged. Low LN2 level. | <ul style="list-style-type: none"> Close the lid, and/or press FILL/START to lower temperature rapidly. Ensure probe is placed correctly. Inspect probe for damage. Check level. Press FILL/START and check supply. |
| Open Fill Visual Alarm SYSTEM STATUS ALARM **OPEN FILL** Fill valve(s) are disconnected from controller. | <ul style="list-style-type: none"> Fill valve(s) are disconnected from power source. Fill valve(s) defective. | <ul style="list-style-type: none"> Check connection on the controller, check wire connection near valves. Replace fill valve(s). |
| Open Bypass Visual Alarm SYSTEM STATUS ALARM **OPEN BYPASS** Bypass valve is disconnected from controller. | <ul style="list-style-type: none"> Bypass valve is disconnected from power source. Bypass valve is defective. | <ul style="list-style-type: none"> Check connection on the controller, check wire connection near valves. Replace bypass valve. <p>Note: Bypass may be turned off until repair is made.</p> |
| Open Probe Alarm Visual Alarm SYSTEM STATUS ALARM **TEMP A PROBE** or TEMP B PROBE** or **OPEN BP PROBE** Controller cannot read the temperature from affected probe. | <ul style="list-style-type: none"> Thermocouple probe is damaged. Thermocouple probe plug is disconnected or damaged. | <ul style="list-style-type: none"> Replace damaged probe. Plug in probe or unplug and plug back in. Replace female connector if required. |
| No power | <ul style="list-style-type: none"> Blown fuse. Power supply failure. May cause controller to flash and “chirp”. | <ul style="list-style-type: none"> Replace with 2-amp slow blow fuse. Replace power supply. |

| | | |
|---|-------------------------|--|
|  | Document Number: | ES-IS-OP001 |
| | Document Title: | Instructions for Use–Cryopreservation Storage Systems |
| | Revision: | D |

31.0 Parts List

| Part Number | Part Description |
|-------------|---|
| V001-0008 | Solenoid Valve, 24V |
| LP-500 | Lid Probe for Series 5000 & Carousel Models |
| LP-153 | Lid Probe for Series 1500 & 3000 |
| E001-0380A | Replacement 2301 Controller, Series 1500 & 3000 |
| E001-0380B | Replacement 2301 Controller for Series 5000 |
| E001-0380C | Replacement 2301 Controller for Carousels |
| 17E9-0003 | Power Supply (North American Cord) for 2301 |
| 17E9-0005 | Power Supply (North American Cord for Carousel or Series 5000) for 2301 |
| 17E9-0004 | Power Supply (Euro Cord) for 2301 |
| 17E9-0006 | Power Supply (Euro Cord for Carousel or Series 5000) for 2301 |
| R001-0030 | Safety Relief Valve, 60PSI |

For questions regarding spare / replacement parts, contact:

Customer / Technical Service:
Phone: (800) 523-0072 (US Only) (586) 331-2600 Fax: (586) 331-2600

customerservice@custombiogenics.com
sales@custombiogenics.com

32.0 Disposal



- Do not dispose of this product as unsorted municipal waste.
- Collect this product separately.
- Use the collection and return systems available locally. For more information on the return, recovery or recycling of this product, please contact your local distributor or Custom BioGenic Systems.

